

# Instruction Manual

**Cordless**  
Drill & Driver  
**EY6230**

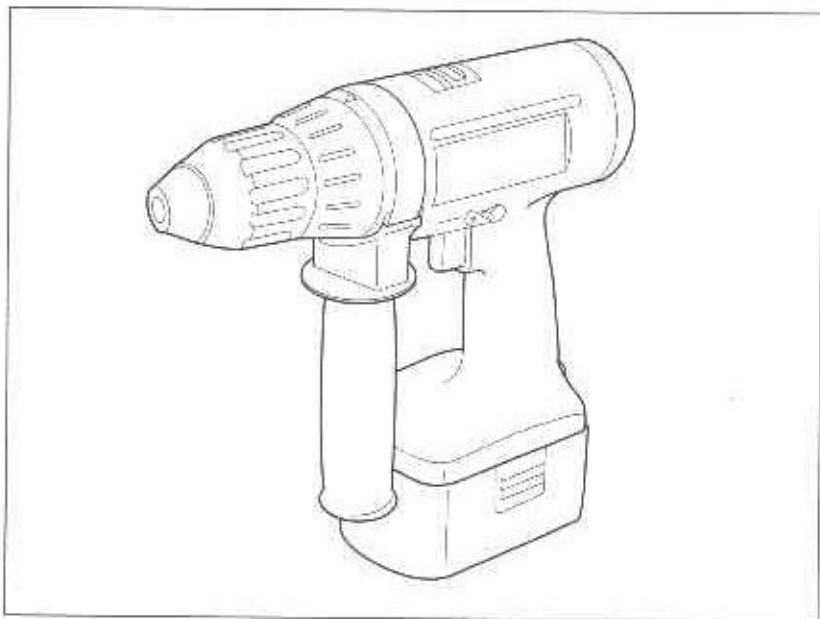

**Panasonic** 

Before operating this unit, please read these instructions completely.



# IMPORTANT SAFETY INSTRUCTIONS

**WARNING:** When using electric tools, basic safety precautions should always be followed to reduce the risk of fire, electric shock and personal injury, including the following:

## READ ALL INSTRUCTIONS BEFORE USING

### 1) KEEP WORK AREA

**CLEAN.** Cluttered areas and benches invite accidents.

### 2) CONSIDER WORK AREA

**ENVIRONMENT.** Do not expose power tools to rain. Do not use power tools in damp or wet locations. Keep work area well lit. Do not use tool in presence of flammable liquids or gases.

### 3) GUARD AGAINST ELECTRIC SHOCK.

Prevent body contact with grounded surfaces. For example; pipes, radiators, ranges, refrigerator enclosures.

### 4) KEEP CHILDREN AWAY.

Do not let visitors contact tool. All visitors should be kept away from work area.

### 5) STORE IDLE TOOLS.

When not in use, tools should be stored in a dry, high or locked-up place — out of reach of children.

### 6) DON'T FORCE TOOL.

It will do the job better and safer at the rate for which it was designed.

### 7) USE RIGHT TOOL.

Don't force small tools or attachments to do the job of a heavy duty tool. Don't use tool for purpose not intended—for example—don't use circular saw for cutting tree limbs or logs.

### 8) WEAR PROPER

**APPAREL.** No loose clothing or jewelry to get caught in moving parts. Rubber gloves and nonskid footwear are recommended when working outdoors. Wear protective hair covering to contain long hair.

### 9) USE SAFETY GLASSES

with most tools. Also use face or dust mask in dusty environment.

### 10) SECURE WORK.

Use clamps or a vise to hold work. It's safer than using your hand and it frees both hands to operate tool.

### 11) DON'T OVERREACH.

Keep proper footing and balance at all times.

### 12) MAINTAIN TOOLS

**WITH CARE.** Keep tools sharp at all times and clean for best and safest performance. Follow instructions for lubricating and changing accessories. Keep handles dry, clean, and free from oil and grease.

### 13) DISCONNECT TOOLS/

**BATTERIES.** When not in use, before servicing, and when changing accessories, such as bits.

### 14) REMOVE ADJUSTING KEYS AND WRENCHES.

Form a habit of checking to see that keys and adjusting wrenches are removed from tool before turning it on.

### 15) AVOID ACCIDENTAL STARTING.

Don't carry tool with finger on switch.

### 16) STAY ALERT.

Watch what you are doing. Use common sense. Do not operate tool when you are tired.

### 17) CHECK DAMAGED

**PARTS.** Before further use of the tools, check guard or other safety devices carefully to determine that they will operate properly and perform their intended function. Check for alignment of moving parts, binding of moving parts, breakage of parts, mounting, and any other conditions that may affect its operation. A guard or other part that is damaged should be properly repaired or replaced by an authorized service center. Have defective parts replaced by an authorized service center. Do not use a defective tool.

# SAVE THESE INSTRUCTIONS

# FOR BATTERY CHARGER & BATTERY PACK

## 1) **SAVE THESE INSTRUCTIONS**

-This manual contains important safety and operating instructions for battery charger EY0212.

2) Before using battery charger, read all instructions and cautionary markings on (1) battery charger, (2) battery pack.

3) **CAUTION** -To reduce the risk of injury, charge only Battery Pack EY9103, EY9101, EY9001, EY9006, EY9180, EY9080, EY9182, EY9086, EY9065, EY9106, EY9107, EY9136, EY9117.

Other types of batteries may burst causing personal injury and damage.

4) Do not expose charger to rain or snow.

5) To reduce risk of damaging the electric plug and cord, pull by plug rather than cord when disconnecting charger.

6) Make sure cord is located so that it will not be stepped on, tripped over, or otherwise subjected to damage or stress.

- 7) An extension cord should not be used unless absolutely necessary. Use of improper extension cord could result in a risk of fire and electric shock. If extension cord must be used, make sure:
- that pins on plug of extension cord are the same number, size and shape as those of plug on charger.
  - that extension cord is properly wired and in good electrical condition.
  - that wire size is large enough for ampere rating of charger as specified below.

RECOMMENDED MINIMUM AWG SIZE OF EXTENSION CORDS FOR BATTERY CHARGERS			
AC Input Rating, Amperes		AWG Size of Cord	
Equal to or greater than	But less than	Length of Cord, Feet	
		25	50 100 150
0	2	18 18	18 16

AC Input Rating, Amperes		AWG Size of Cord	
Equal to or greater than	But less than	Length of Cord, Feet	
		25	50 100 150
0	2	18 18	18 16

8) Do not operate charger with damaged cord or plug—replace them immediately.

9) Do not operate charger if it has received a sharp blow, been dropped, or otherwise damaged in any way; take it to a qualified serviceman.

10) Do not disassemble charger; take it to a qualified serviceman when service or repair is required. Incorrect reassembly may result in a risk of electric shock or fire.

11) To reduce the risk of electric shock, unplug charger from outlet before attempting any maintenance or cleaning.

12) The charger and battery pack are specifically designed to work together. Do not attempt to charge any other cordless tool or battery pack with this charger.

13) Do not attempt to charge the battery pack with any other charger.

14) Do not attempt to disassemble the battery pack housing.

# ADDITIONAL SAFETY RULES

- 15) Do not store the tool and battery pack in locations where the temperature may reach or exceed 122°F (50°C) (such a metal tool shed, or a car in the summer), which can lead to deterioration of the storage battery.
  - 16) Do not charge battery pack when the temperature is BELOW 32°F (0°C) or ABOVE 104°F (40°C). This is very important.
  - 17) Do not incinerate the battery pack. It can explode in a fire.
  - 18) Avoid dangerous environment. Do not use charger in damp or wet locations.
  - 19) The charger is designed to operate on standard household electrical power only. Do not attempt to use it on any other voltage!
  - 20) Do not abuse cord. Never carry charger by cord or yank it to disconnect from outlet. Keep cord away from heat, oil and sharp edges.
  - 21) Charge the battery pack in a well ventilated place, do not cover the charger and battery pack with a cloth, etc., while charging.
  - 22) Use of an attachment not recommended may result in a risk of fire, electric shock, or injury to persons.
  - 23) Do not short the battery pack. A battery short can cause a large current flow, over heating and burns.
  - 24) NOTE: If the supply cord of this appliance is damaged, it must only be replaced by a repair shop appointed by the manufacturer, because special purpose tools are required.
  - 25) TO REDUCE THE RISK OF ELECTRIC SHOCK, THIS APPLIANCE HAS A POLARIZED PLUG (ONE BLADE IS WIDER THAN THE OTHER).  
This plug will fit in a polarized outlet only one way. If the plug does not fit fully in the outlet, reverse the plug. If it still does not fit, contact a qualified electrician to install the proper outlet. Do not change the plug in any way.
- 1) Be aware that this tool is always in an operating condition, since it does not have to be plugged into an electrical outlet.
  - 2) When drilling or driving into walls, floors, etc., "live" electrical wires may be encountered. DO NOT TOUCH THE CHUCK OR ANY FRONT METAL PARTS OF THE TOOL! Hold the tool only by the plastic handle to prevent electric shock in case you drill or drive into a "live" wire.
  - 3) If the bit becomes jammed, immediately turn the main switch off to prevent an overload which can damage the battery pack or motor. Use reverse motion to loosen jammed bits.
  - 4) Do not operate the reversing lever when the main switch is on. The battery will discharge rapidly and damage to the unit may occur.
  - 5) During charging, the charger may become slightly warm. This is normal. Do not charge the battery for a long period.
  - 6) Use only a dry, soft cloth for wiping the unit. Do not use a damp cloth, thinner, benzine, or other volatile solvents for cleaning.
  - 7) When storing or carrying the tool, set the reversing lever to the center (switch lock) position.
  - 8) Do not strain the tool by holding the speed control trigger halfway (speed control mode) so that the motor stops.
  - 9) Do not operate the speed selector switch (LOW-HIGH) while pulling on the speed control trigger. This can cause the rechargeable battery to wear quickly or damage the internal mechanism of the motor.

• Changes or modifications not expressly approved by MATSUSHITA ELECTRIC WORKS, LTD. could void the user's authority to operate the equipment.

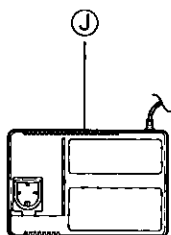
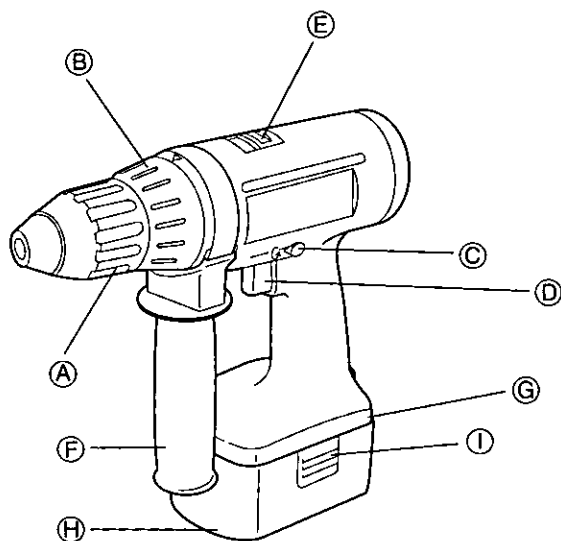

(A)	Keyless drill chuck
(B)	Clutch handle
(C)	Reversing lever
(D)	Variable speed control trigger
(E)	Speed selector switch
(F)	Auxiliary handle
(G)	Bit holder
(H)	Battery pack (EY9136)
(I)	Battery pack release button
(J)	Battery charger (EY0212)

# PARTS IDENTIFICATION

## Ⓐ Keyless drill chuck

**Note:** When attaching or removing a bit, be sure to set the reversing lever to its center position (switch lock).

This tool is equipped with a keyless drill chuck.

### 1. Attachment

Insert the bit and turn the lock collar clockwise (looking from the front) to tighten.

When the clicking sounds stop while tightening, attachment is completed.

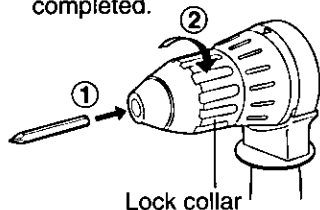

### 2. Removal

Turn the lock collar counterclockwise (looking from the front), then remove the bit.

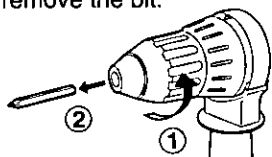

**Note:** If excessive play occurs in the chuck, ① secure the drill in place and tighten the chuck by turning Ⓐ clockwise, ② open the chuck claws by unscrewing the lock collar and ③ tighten the screw (left-handed screw) with a screwdriver by turning it counterclockwise (viewed from the front).

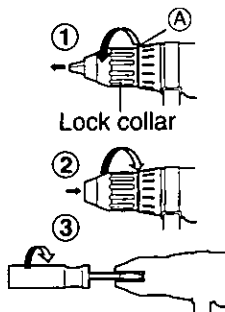

## Ⓑ Clutch Handle (Clutch Torque Setting)



Adjust the torque to one of the 21 possible settings to the job. There is an interval of about 0.3 Nm (3 kg-cm or 2.6 in-lbs) between steps.

**CAUTION!** Test the setting before actual operation.

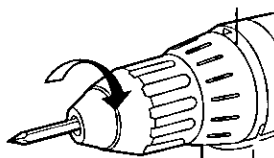
Set the scale at this line





### Reference for Adjusting Torque

Scale	Torque	Use
1	Approx. 1.0 Nm (10 kgf-cm or 8.7 in-lbs.)	For driving terminal screws
6	Approx. 2.5 Nm (25 kgf-cm or 21.7 in-lbs.)	For driving machine screws
11	Approx. 3.9 Nm (40 kgf-cm or 37.7 in-lbs.)	For driving screws into soft materials
16	Approx. 5.4 Nm (55 kgf-cm or 47.7 in-lbs.)	For driving screws into hardwood
21	Approx. 6.9 Nm (70 kgf-cm or 60.7 in-lbs.)	
	High speed	For powerful driving and drilling
	Low speed	

### Bit-locking function

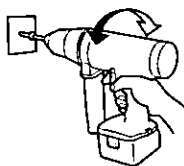
- With the trigger switch not engaged and a screwdriver bit locked in place, and the tool can be used as a manual screwdriver (up to 22.5 Nm, 230 kgf-cm, 199 in-lbs.). There will be a little play in the chuck, but this is not a malfunction.



- This feature is handy for tightening screws that require more torque than the maximum torque of the driver (position  on the clutch), for confirming the tightness of a screw or to loosen an extremely tight screw.

Ⓒ **Reversing lever**  
**(Forward, Switch lock, Reverse)**

**CAUTION!** Release the trigger switch to OFF and wait until the bit has come to a complete stop before operating this lever.

1. For reverse rotation, set the lever to reverse. Check the direction of rotation before use.
2. After use, set the lever to its center position (switch lock).

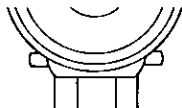

Ⓕ **Auxiliary handle**

Place the auxiliary handle at your favorite position and tighten the handle securely.

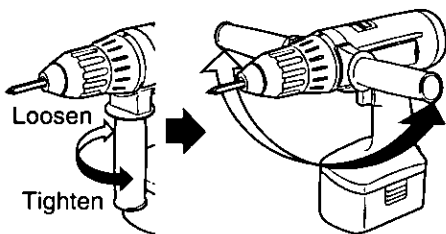

Ⓖ **Variable speed control trigger**

1. Depress the trigger switch slightly to start the tool slowly.
2. The speed increases with the amount of depression of the trigger for efficient tightening of screws and drilling. The brake operates and the chuck stops immediately when the trigger is released.

**Note:** When the brake operates, a braking sound may be heard. This sound indicates engagement of the bit lock.

- Do NOT strain the tool (motor). This may cause damage to the unit.

**Caution:** To eliminate excessive temperature increase of the tool surface, do not operate the tool continuously using two or more battery packs.  
Tool needs cool off time before switching to another pack.

Ⓖ **Bit holder**

Remove the battery pack to expose the bit storage compartment inside the handle housing. Bits up to 45 mm (1-25/32 inch) long can be stored here.

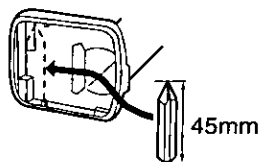

Ⓖ **Speed selector switch**

Choose a low or high speed to suit the use.

The more the speed control trigger is pulled, the higher the speed.

**CAUTION:** Check the speed selection before operating this tool.



## H Battery pack (EY9136)

1. Press the battery pack release buttons ⊕ on both sides and pull the pack away from the tool.
2. Charge the battery pack using the battery charger.
3. After the charging has been completed, remove the battery pack from the charger and connect it to the tool. Disconnect the charger from the A.C. outlet when not in use.

### Battery Pack Life

The rechargeable batteries have a limited life. If the operation time becomes extremely short after recharging, replace the battery with a new one. If the tool is not frequently used, charge the battery pack at least once every six months to maintain battery performance.

**Note:** Use under extremely hot or cold conditions will reduce operation capacity per charge.

### ATTENTION:

The nickel cadmium battery you have purchased is recyclable. At the end of its useful life, under various state and local laws, it is illegal to dispose of this battery into your municipal waste stream. Please call 1-800-8-BATTERY for information on how to recycle this battery.



## I Battery pack release button

## J Battery charger (EY0212)

**Note:** Charge a new battery pack, or a battery pack that has not been used for a prolonged time, for about 24 hours to bring the battery up to full charge.

## EY0212

1. Plug the charger into an AC outlet.
2. Open the cap and insert the battery pack firmly into the charger.

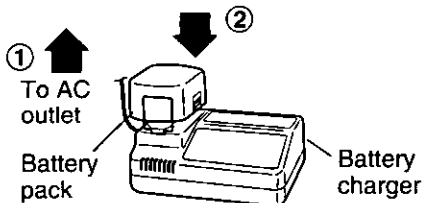

3. During charging, the charging lamp will be lit.

When charging is completed, an internal electronic switch will automatically be triggered to prevent overcharging.

- Charging will not start if the battery pack is warm (for example, immediately after heavy-duty operation). The orange standby lamp will be lit until the battery cools down. Charging will then begin automatically.
4. When charging is completed, the charging lamp will start flashing rapidly.
  5. If the charger is too hot by charging more than two battery packs consecutively, charging a battery pack that has not been used for a long time or the ambient temperature is rather low, the charging lamp starts flashing slowly. It indicates protective charging and it takes more time than standard charging time until the battery pack is fully charged.
    - If a fully charged battery pack is inserted into the charger again, the charging lamp may light up and then flash slowly. After several minutes, the charging lamp may flash quickly to indicate the charging is completed.
  6. If the charging lamp does not light immediately after the charger is plugged in, or if after the standard charging time the lamp does not go off, consult an authorized dealer.

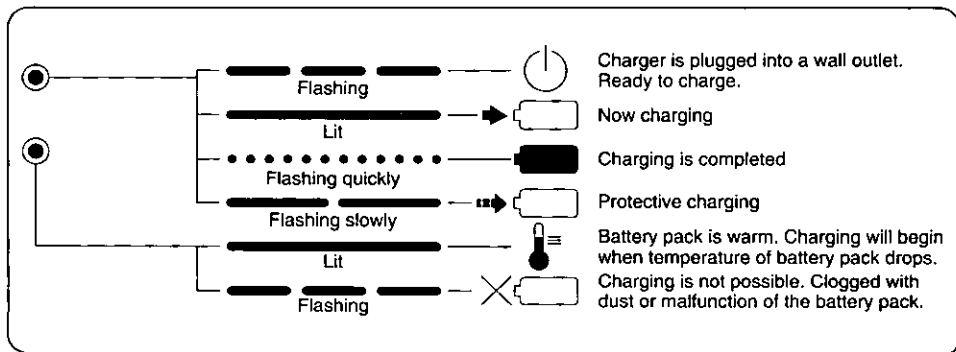

## SPECIFICATIONS

### VARIABLE SPEED CORDLESS COMBINATION DRILL & DRIVER (EY6230)

Capability	Screw driving	Machine screw	M3~M6
		Wood screw	$\phi$ 2.1~ $\phi$ 8mm (5/64"~5/16")
		Self-drilling screw	$\phi$ 3~ $\phi$ 6mm (1/8"~15/64")
	Drilling	Wood	$\phi$ 3~ $\phi$ 36mm (1/8"~1-25/64")
Steel		$\phi$ 1.6~ $\phi$ 13mm (1/16"~1/2")	
Motor	DC Motor 15.6V		
No load speed	LOW: 65~450min (rpm.) HIGH: 200~1450min (rpm.)		
Chuck capacity	1.6mm~13mm (1/16"~1/2")		
Maximum torque	LOW: 30.9Nm, 315kgf-cm, 273in-lbs. HIGH: 8.33Nm, 85kgf-cm, 73.3in-lbs.		
Maximum clutch torque	6.9Nm (70kg-cm, 61in. lbs.)		
Overall length	237mm		
Weight (with battery pack)	2.3kg, 5.1 lbs.		

### BATTERY BACK (EY9136)

Storage battery	Ni-Cd battery
Battery voltage	15.6V DC (12V $\times$ 13cells)

### BATTERY CHARGER (EY0212)

Input	120V AC
Weight	1.7kg, 3.8 lbs.

24V	15.6V	12V	9.6V	7.2V	CHARGING TIME
---	---	EY9001, EY9006	EY9080, EY9086	EY9065	APPROX. 20min
---	---	EY9101, EY9103	EY9180, EY9182	---	APPROX. 25min
EY9117	EY9136	EY9106, EY9107	---	---	APPROX. 30min



**PANASONIC HOME & COMMERCIAL PRODUCTS COMPANY**  
One Panasonic Way, Secaucus, New Jersey 07094